

Features

- Floating channel designed for bootstrap operation
- Fully operational to +200V
- Tolerant to negative transient voltage, dV/dt immune
- Gate drive supply range from 10V to 20V
- Undervoltage lockout
- 3.3V, 5V, and 15V logic compatible
- Cross-conduction prevention logic
- Matched propagation delay for both channels
- Outputs in phase with inputs
- Leadfree, RoHS compliant

Description

The IRS2001 is a high voltage, high speed power MOSFET and IGBT driver with dependent high and low side referenced output channels. Proprietary HVIC and latch immune CMOS technologies enable ruggedized monolithic construction. The logic input is compatible with standard CMOS or LSTTL output, down to 3.3V logic. The output drivers feature a high pulse current buffer stage designed for minimum driver cross-conduction. The floating channel can be used to drive an N-channel power MOSFET or IGBT in the high side configuration which operates up to 200V.

Product Summary

Topology	General Driver
V_{OFFSET}	$\leq 200\text{V}$
V_{OUT}	10V – 20V
$I_{\text{o+}}$ & $I_{\text{o-}}$ (typical)	290mA & 600mA
t_{on} & t_{off} (typical)	160ns & 150ns
Delay Matching (Max.)	50ns

Package Options



MLPQ4x4 - 16 Leads
(Without 2 leads)

Typical Connection

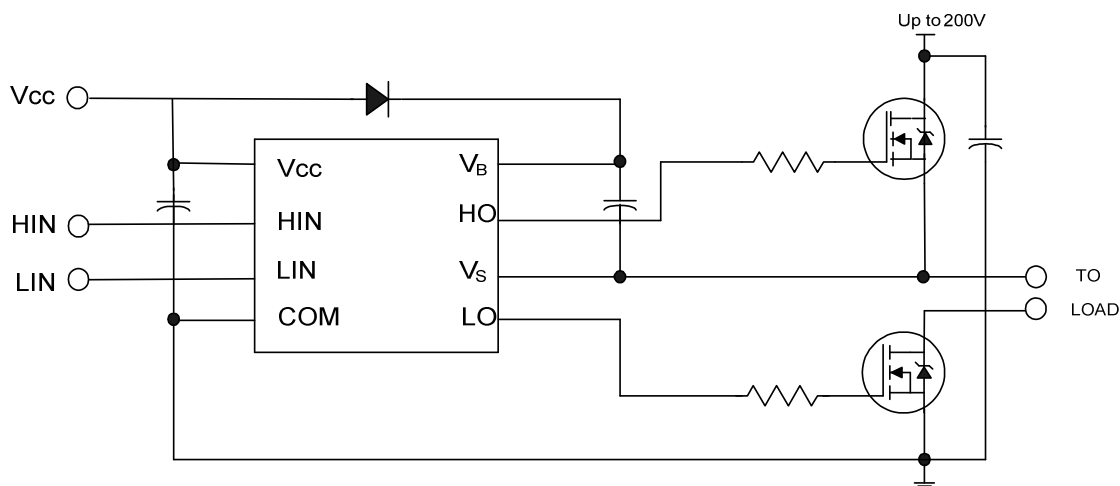

(Refer to Lead Assignments for correct pin configuration) This diagram shows electrical connections only. Please refer to our Application Notes and Design Tips for proper circuit board layout.

Qualification Information[†]

Qualification Level		Industrial ^{††} (per JEDEC JESD 47)	
		Comments: This IC has passed JEDEC's Industrial qualification. IR's Consumer qualification level is granted by extension of the higher Industrial level.	
Moisture Sensitivity Level		MLPQ4x4 14L	MSL2 ^{†††} (per IPC/JEDEC J-STD-020)
ESD	Machine Model	Class A (+/-200V) (per JEDEC standard JESD22-A115A)	
	Human Body Model	Class 1C (+/-2000V) (per JEDEC standard JESD22-A114F)	
	Charged Device Model	Class III (+/-1000V) (per JEDEC standard JESD22-C101D)	
IC Latch-Up Test		Class II, Level B (per AEC-Q100-004)	
RoHS Compliant		Yes	

† Qualification standards can be found at International Rectifier's web site <http://www.irf.com/>

†† Higher qualification ratings may be available should the user have such requirements. Please contact your International Rectifier sales representative for further information.

††† Higher MSL ratings may be available for the specific package types listed here. Please contact your International Rectifier sales representative for further information.

Absolute Maximum Ratings

Absolute Maximum Ratings indicate sustained limits beyond which damage to the device may occur. All voltage parameters are absolute voltages referenced to COM. The thermal resistance and power dissipation ratings are measured under board mounted and still air conditions.

Symbol	Definition	Min.	Max.	Units
V_B	High side floating absolute voltage	-0.3	225	V
V_S	High side floating supply offset voltage	$V_B - 25$	$V_B + 0.3$	
V_{HO}	High side floating output voltage	$V_S - 0.3$	$V_B + 0.3$	
V_{CC}	Low side and logic fixed supply voltage	-0.3	25	
V_{LO}	Low side output voltage	-0.3	$V_{CC} + 0.3$	
V_{IN}	Logic input voltage (HIN & LIN)	-0.3	$V_{CC} + 0.3$	
dV_S/dt	Allowable offset supply voltage transient	—	50	V/ns
P_D	Package power dissipation @ $T_A \leq 25^\circ\text{C}$	—	2.08	W
R_{thJA}	Thermal resistance, junction to ambient	—	36	$^\circ\text{C/W}$
T_J	Junction temperature	—	150	$^\circ\text{C}$
T_S	Storage temperature	-55	150	
T_L	Lead temperature (soldering, 10 seconds)	—	300	

Recommended Operating Conditions

The input/output logic timing diagram is shown in Fig 1. For proper operation the device should be used within the recommended conditions. The V_S offset rating is tested with all supplies biased at 15V differential.

Symbol	Definition	Min.	Max.	Units
V_B	High side floating supply absolute voltage	$V_S + 10$	$V_S + 20$	V
V_S	High side floating supply offset voltage	†	200	
V_{HO}	High side floating output voltage	V_S	V_B	
V_{CC}	Low side and logic fixed supply voltage	10	20	
V_{LO}	Low side output voltage	0	V_{CC}	
V_{IN}	Logic input voltage	0	V_{CC}	
T_A	Ambient temperature	-40	125	$^\circ\text{C}$

† Logic operational for V_S of -5V to +200V. Logic state held for V_S of -5V to $-V_{BS}$. (Please refer to the Design Tip DT97-3 for more details).

Dynamic Electrical Characteristics

$V_{BIAS}(V_{CC}, V_{BS}) = 15V$, $C_L = 1000pF$, $T_A = 25^\circ C$ unless otherwise specified.

Symbol	Definition	Min	Typ	Max	Units	Test Conditions
t_{on}	Turn-on propagation delay	—	160	220	ns	$V_S = 0V$
t_{off}	Turn-off propagation delay	—	150	220		$V_S = 200V$
t_r	Turn-on rise time	—	70	170		
t_f	Turn-off fall time	—	35	90		
MT	Delay Matching, HS & LS turn-on/off	—	—	50		

Static Electrical Characteristics

$V_{BIAS}(V_{CC}, V_{BS}) = 15V$ and $T_A = 25^\circ C$ unless otherwise specified. The V_{IN} , V_{TH} , and I_{IN} parameters are referenced to COM. The V_O and I_O parameters are referenced to COM and are applicable to the respective output leads: HO and LO.

Symbol	Definition	Min	Typ	Max	Units	Test Conditions
V_{IH}	Logic "1" input voltage	2.5	—	—	V	$V_{CC} = 10V$ to $20V$
V_{IL}	Logic "0" input voltage	—	—	0.8		
V_{OH}	High level output voltage, $V_{BIAS} - V_O$	—	0.05	0.2		$I_O = 2mA$
V_{OL}	Low level output voltage, V_O	—	0.02	0.1		
I_{LK}	Offset supply leakage current	—	—	50	μA	$V_B = V_S = 200V$
I_{QBS}	Quiescent V_{BS} supply current	—	30	55		$V_{IN} = 0V$ or $5V$
I_{QCC}	Quiescent V_{CC} supply current	—	150	270		
I_{IN+}	Logic "1" input bias current	—	3	10		$V_{IN} = 5V$
I_{IN-}	Logic "0" input bias current	—	—	5		$V_{IN} = 0V$
V_{CCUV+}	V_{CC} supply undervoltage positive going threshold	8.0	8.9	9.8	V	
V_{CCUV-}	V_{CC} supply undervoltage negative going threshold	7.4	8.2	9.0		
I_{O+}	Output high short circuit pulsed current	130	290	—	mA	$V_O = 0V$, $V_{IN} = \text{Logic "1"}$ $PW \leq 10 \mu s$
I_{O-}	Output low short circuit pulsed current	270	600	—		$V_O = 15V$, $V_{IN} = \text{Logic "0"}$ $PW \leq 10 \mu s$

Functional Block Diagram

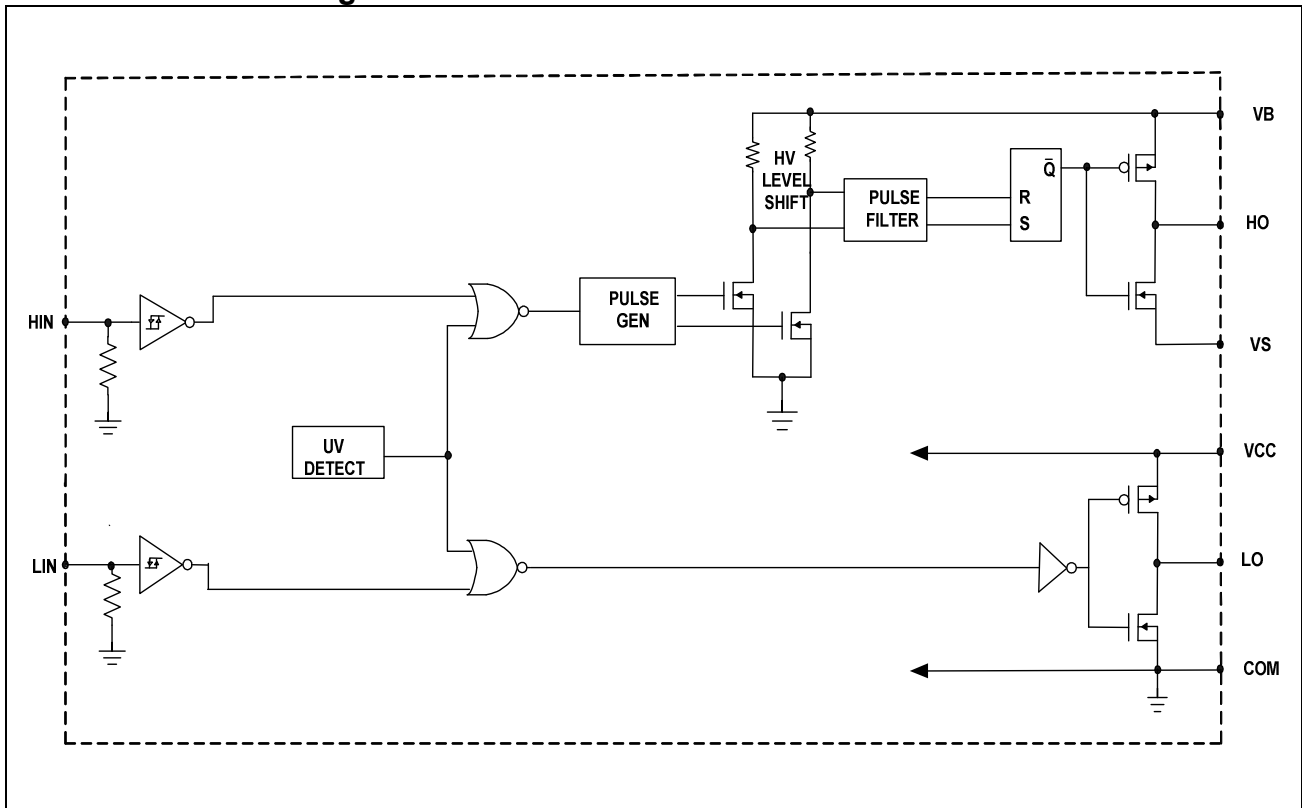

Lead Definitions

PIN	Symbol	Description
1	NC	No connection
2	HIN	Logic input for high side gate driver output (HO), in phase
3	LIN	Logic input for low side driver output (LO), in phase
4	COM	Low side return
5	NC	No Connection
6	NC	No Connection
7	LO	Low side gate drive output
8	NC	No Connection
9	NC	No Connection
10	NC	No Connection (pin removed)
11	V _S	High side floating supply return
12	HO	High side gate drive output
13	V _B /V _{BZ}	High side floating supply
14	NC	No Connection
15	NC	No Connection (pin removed)
16	V _{CC} /V _{CCZ}	Low side and logic fixed supply

Lead Assignments

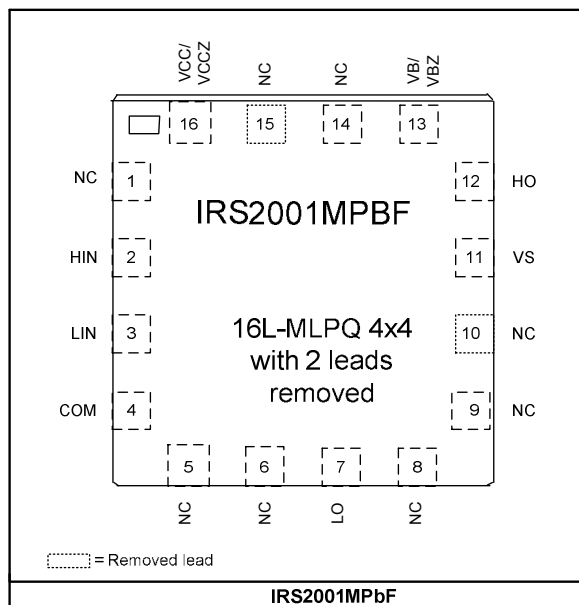

Application Information and Additional Details

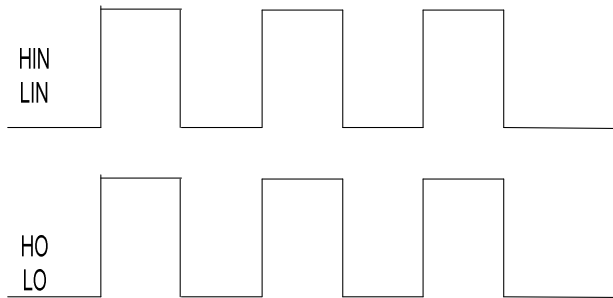

Figure 1: Input/Output Timing Diagram

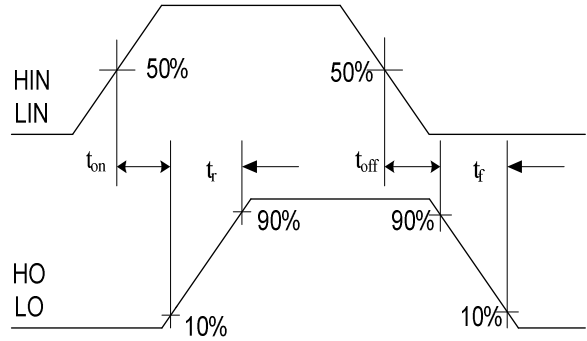

Figure 2: Switching Time Waveform Definitions

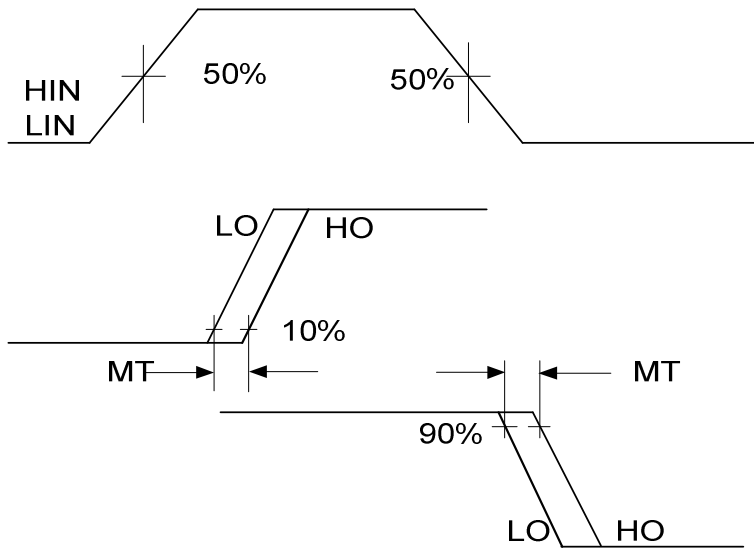

Figure 3: Delay Matching Waveform Definitions

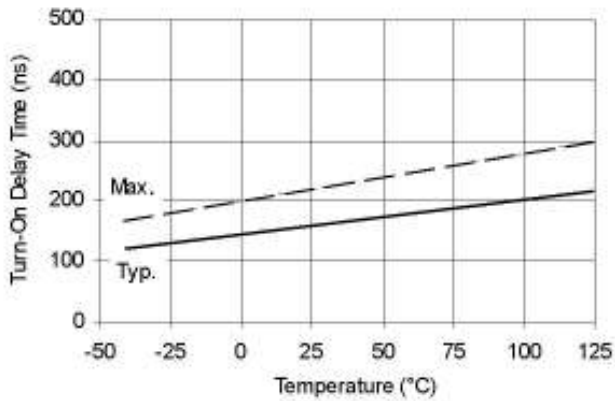

Figure 6A. Turn-On Time vs. Temperature

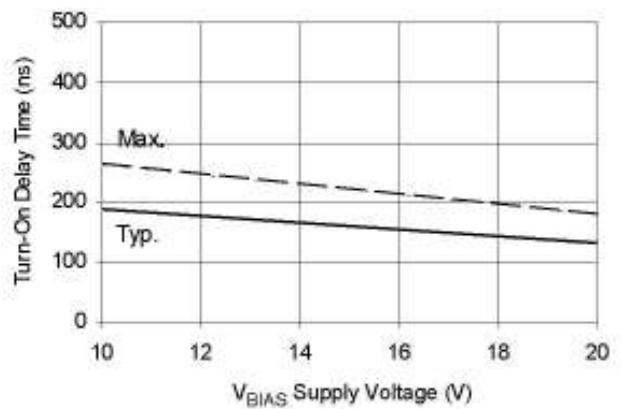

Figure 6B. Turn-On Time vs. Supply Voltage

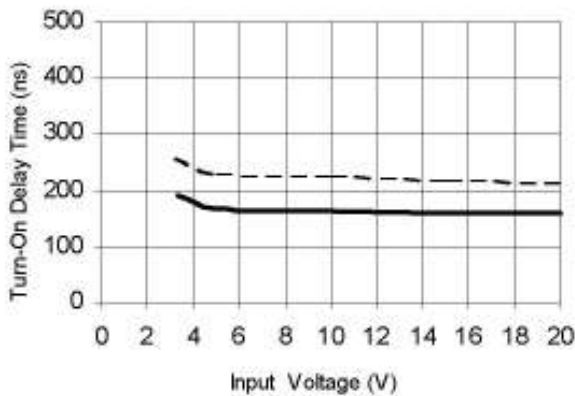

Figure 6C. Turn-On Time vs. Input Voltage

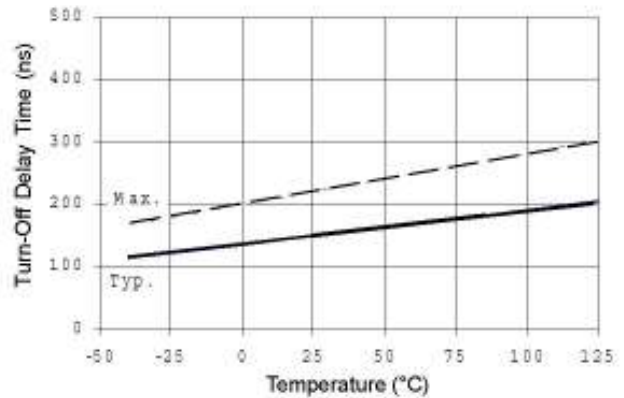

Figure 7A. Turn-Off Time vs. Temperature

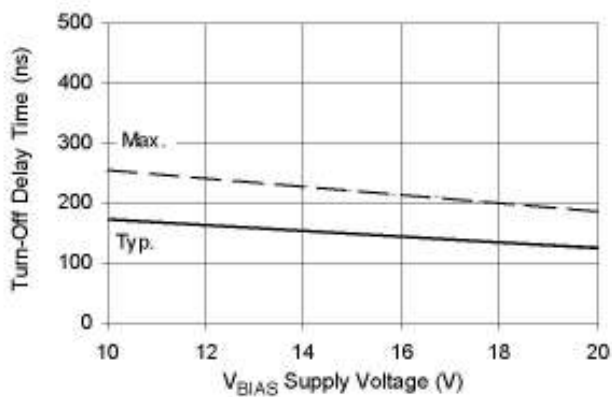

Figure 7B. Turn-Off Time vs. Supply Voltage

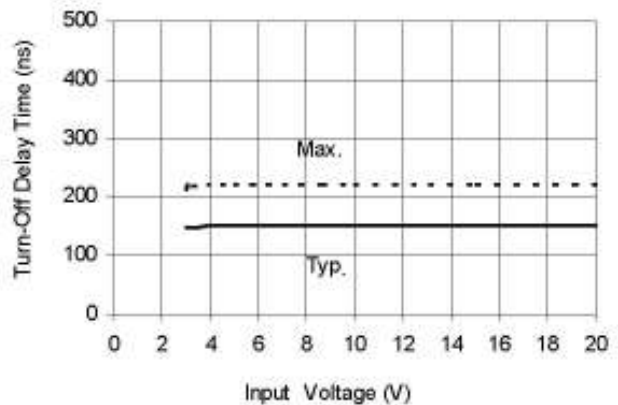

Figure 7C. Turn-Off Time vs. Input Voltage

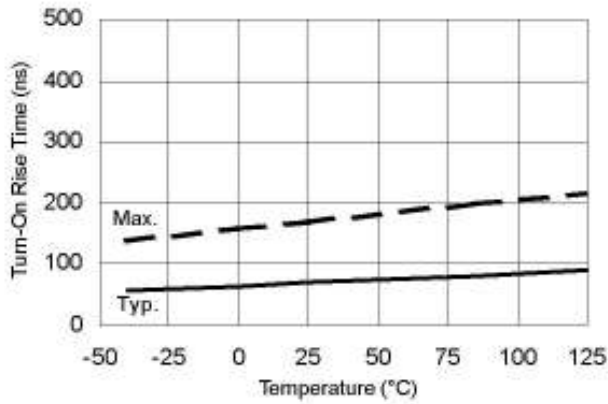

Figure 9A. Turn-On Rise Time vs. Temperature

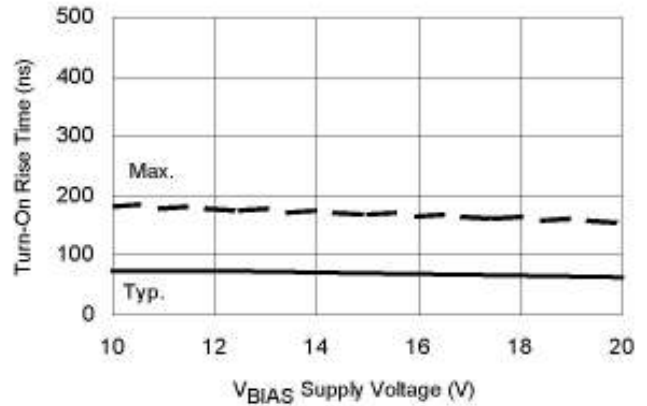

Figure 9B. Turn-On Rise Time vs. Voltage

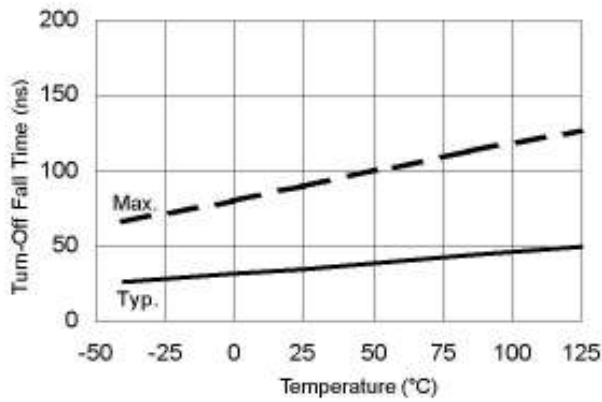

Figure 10A. Turn-Off Fall Time vs. Temperature

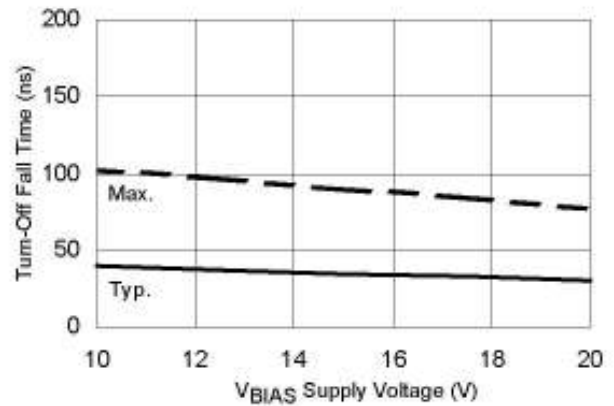

Figure 10B. Turn-Off Fall Time vs. Voltage

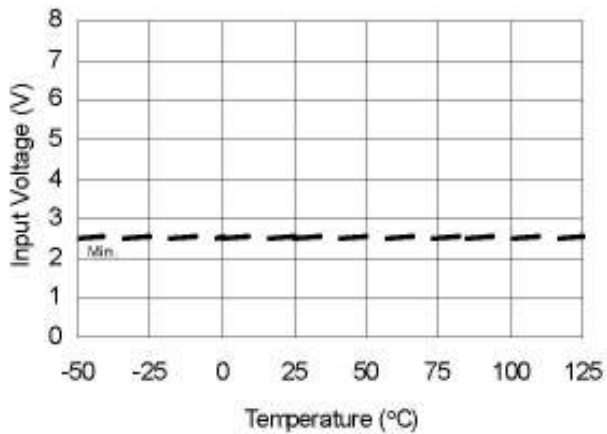

Figure 12A. Logic "1" Input Voltage vs. Temperature

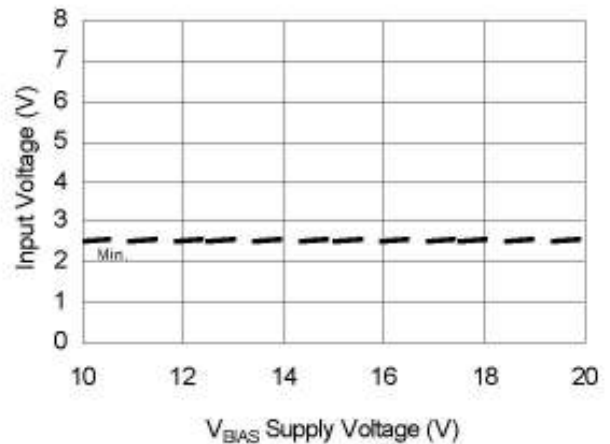

Figure 12B. Logic "1" Input Voltage vs. Voltage

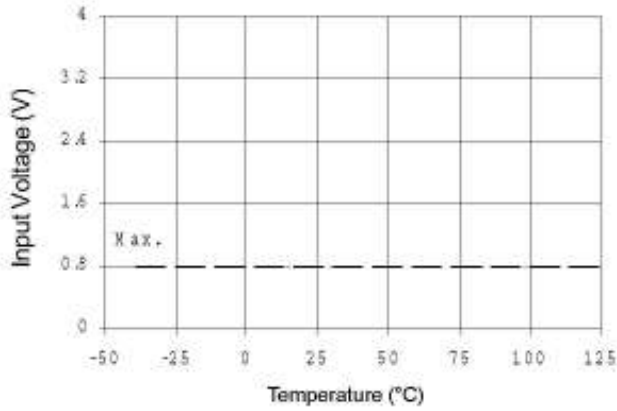

Figure 13A. Logic "0" Input Voltage vs. Temperature

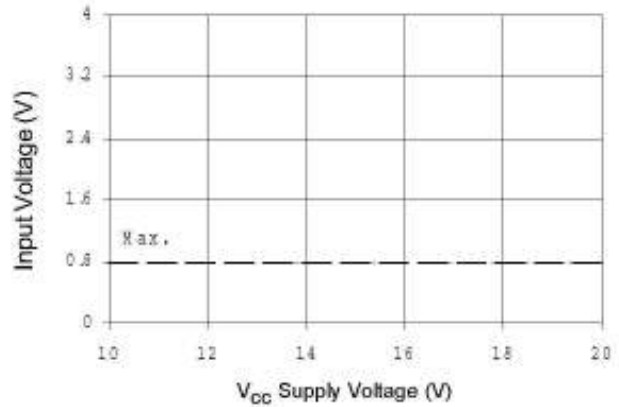

Figure 13B. Logic "0" Input Voltage vs. Supply Voltage

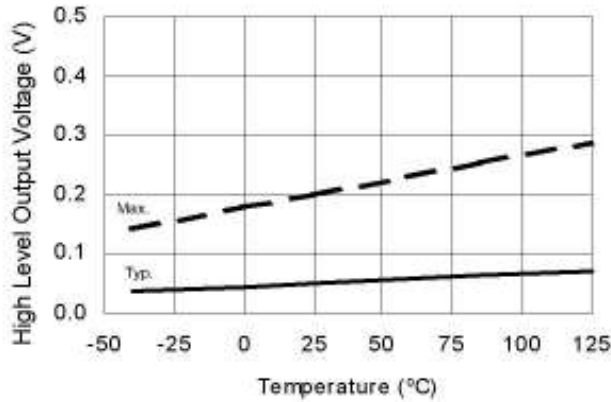

Figure 14A. High Level Output Voltage vs. Temperature

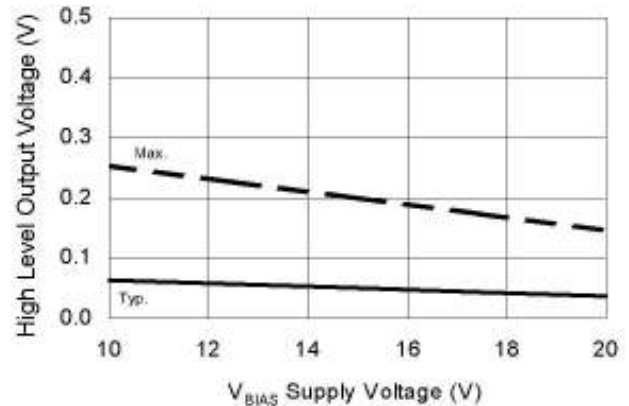

Figure 14B. High Level Output vs. Supply Voltage

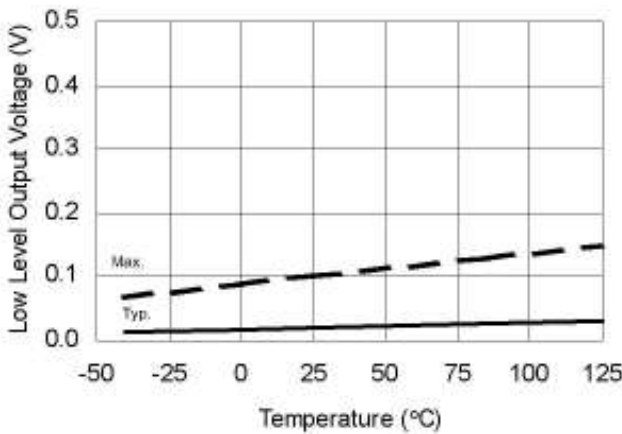

Figure 15A. Low Level Output Voltage vs. Temperature

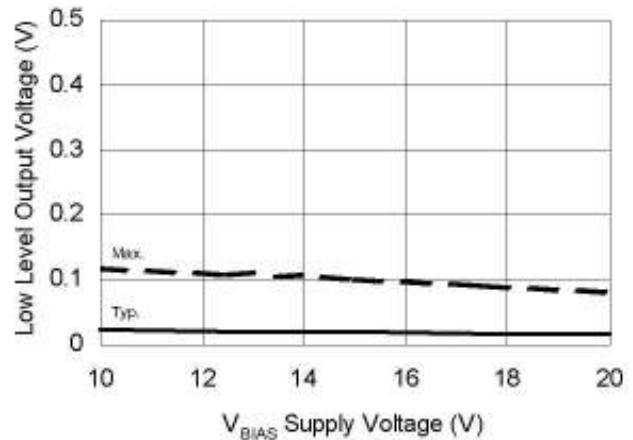

Figure 15B. Low level Output vs. Supply Voltage

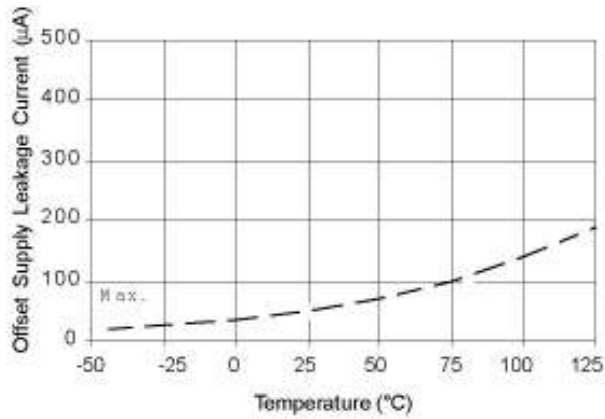

Figure 16A. Offset Supply Current vs. Temperature

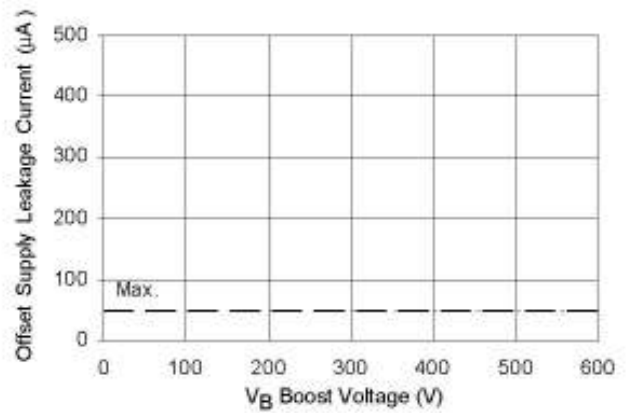

Figure 16B. Offset Supply Current vs. Voltage

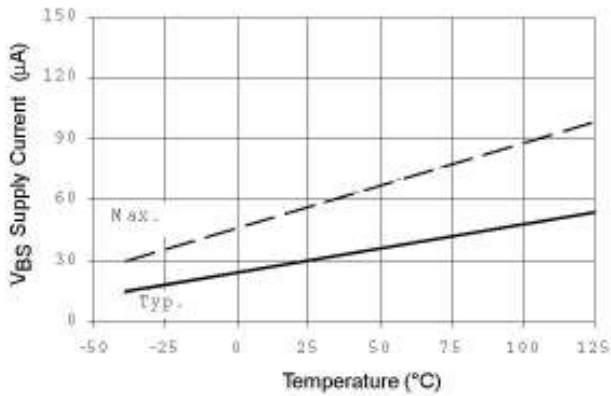

Figure 17A. V_{BS} Supply Current vs. Temperature

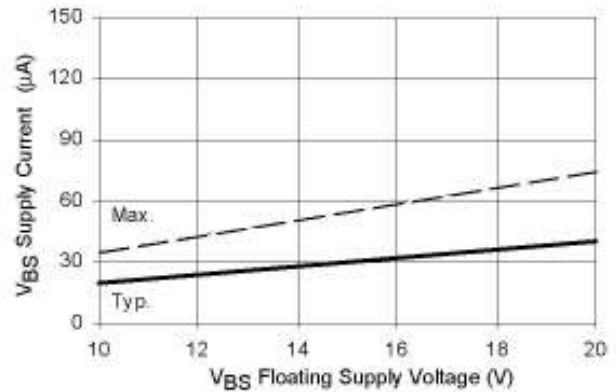

Figure 17B. V_{BS} Supply Current vs. Voltage

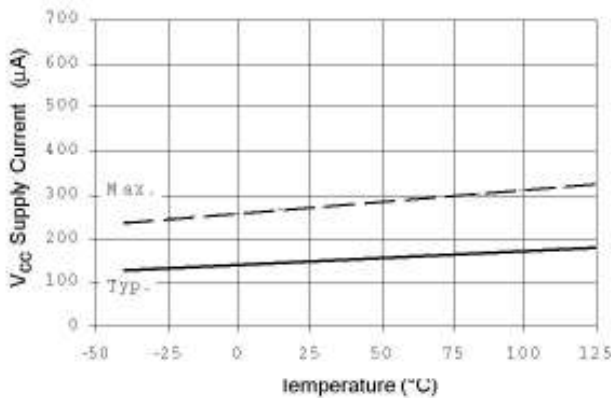

Figure 18A. V_{CC} Supply Current vs. Temperature

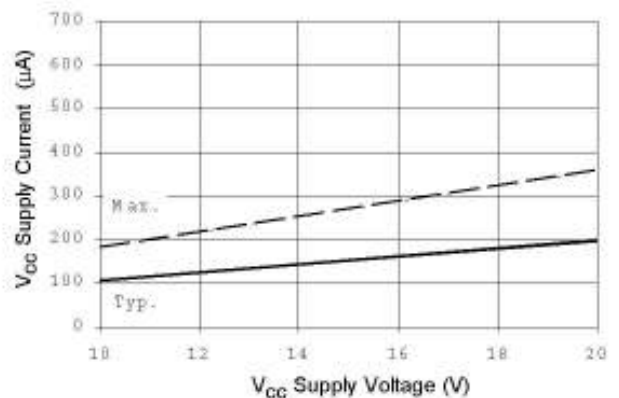

Figure 18B. V_{CC} Supply Current vs. Voltage

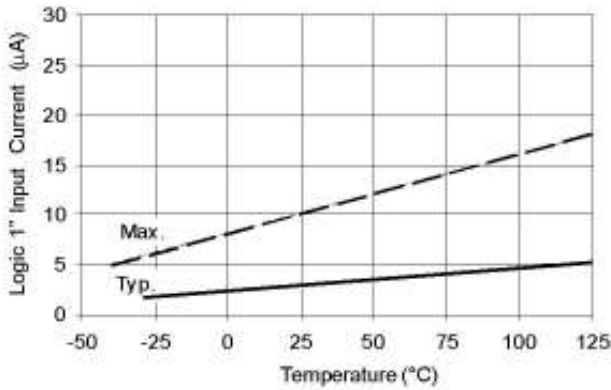

Figure 19A. Logic "1" Input Current vs. Temperature

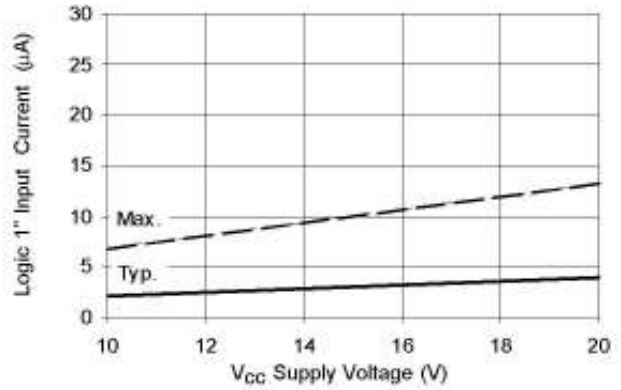

Figure 19B. Logic "1" Input Current vs. Voltage

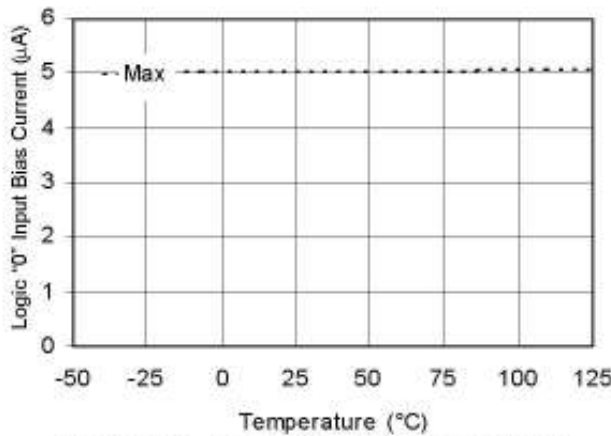

Figure 20A. Logic "0" Input Bias Current vs. Temperature

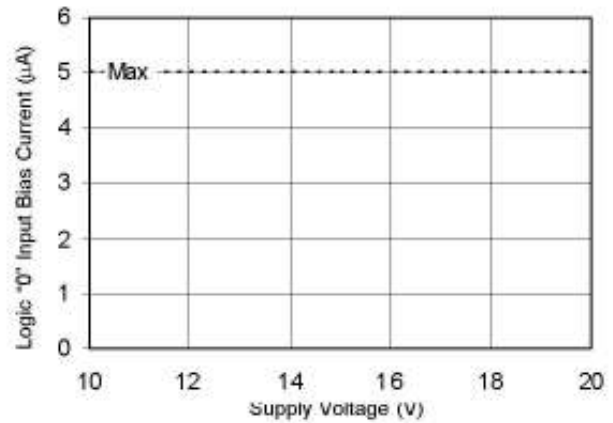

Figure 20B. Logic "0" Input Bias Current vs. Voltage

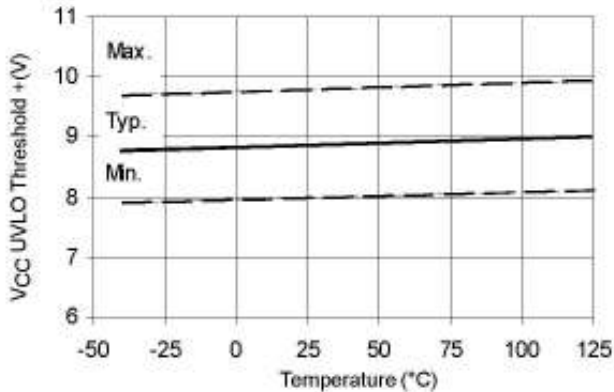

Figure 21A. VCC Undervoltage Threshold(+) vs. Temperature

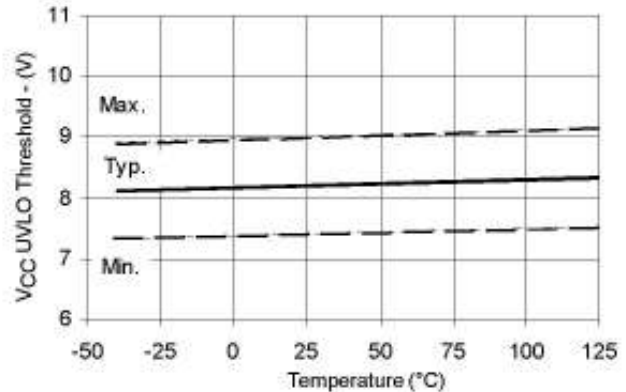

Figure 21B. VCC Undervoltage Threshold(-) vs. Temperature

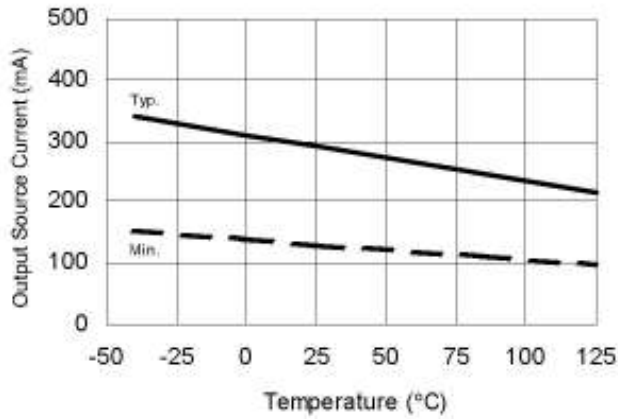

Figure 22A. Output Source Current vs. Temperature

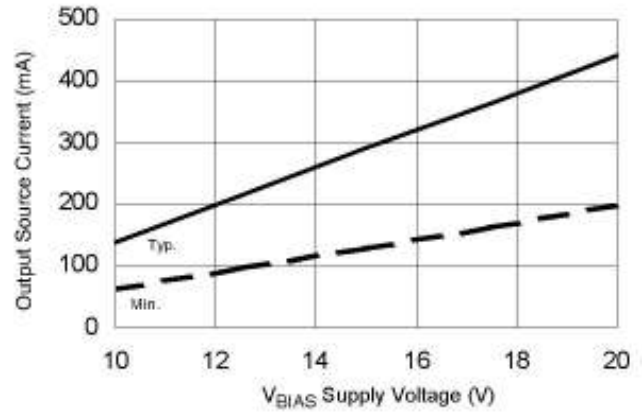

Figure 22B. Output Source Current vs. Supply Voltage

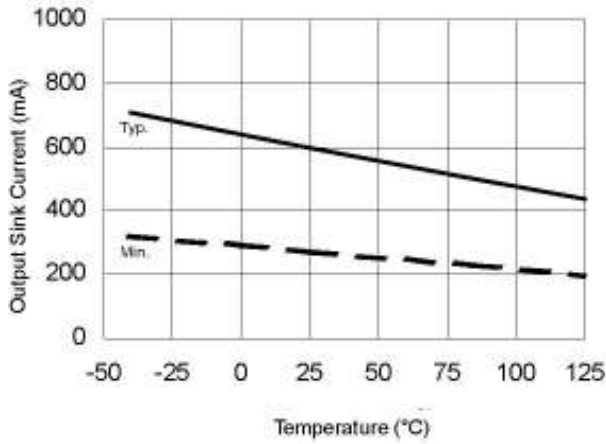

Figure 23A. Output Sink Current vs. Temperature

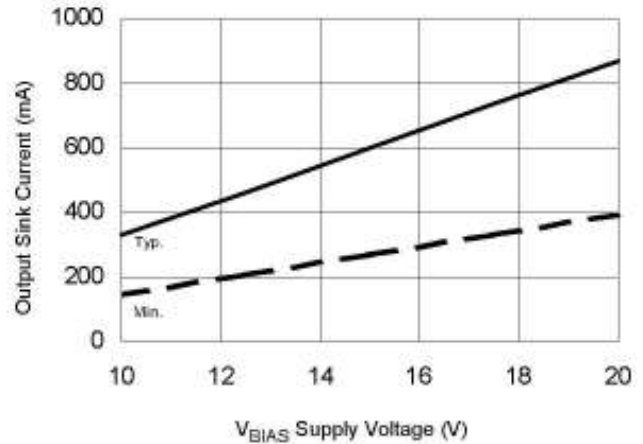
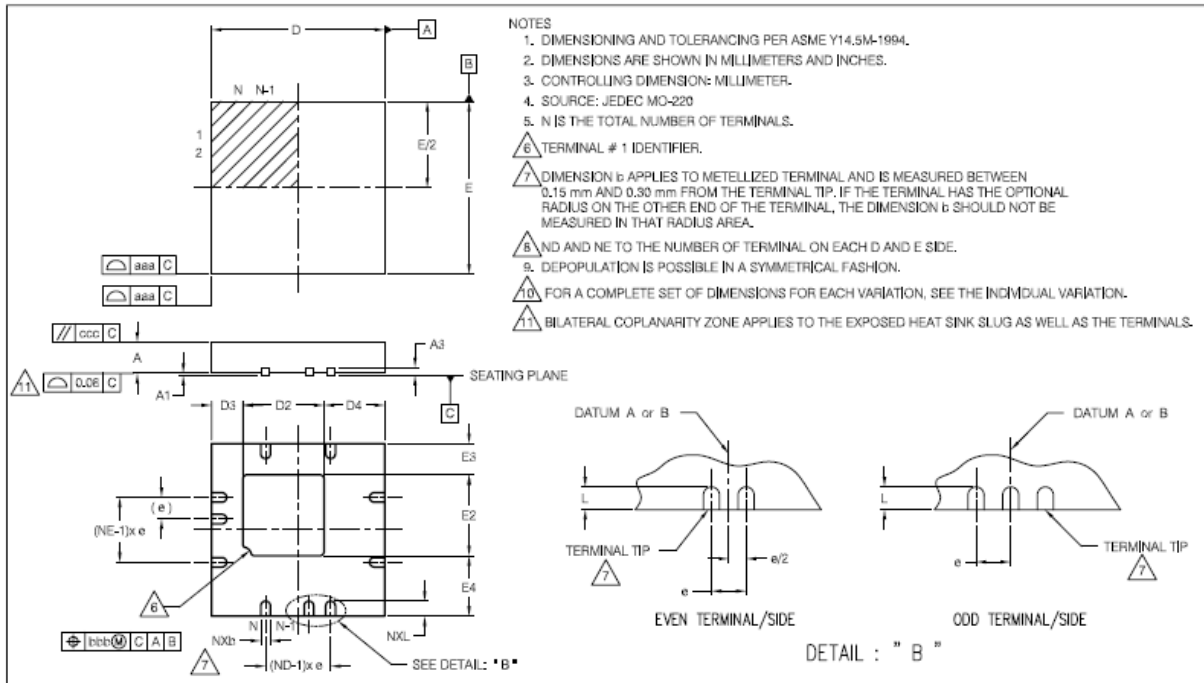

Figure 23B. Output Sink Current vs. Supply Voltage

Package Details: MLPQ 4x4 -14L



SYMBOL	VGGD-10					
	MILLIMETERS			INCHES		
	MIN	NOM	MAX	MIN	NOM	MAX
A	0.90	0.90	1.00	.032	.035	.039
A1	0.00	0.02	0.05	.000	.0008	.0019
A3	0.20 REF			.008 REF		
b	0.18	0.25	0.30	.007	.010	.012
D2	1.78	1.88	1.98	.070	.074	.078
D3	0.73 REF			.029 REF		
D4	1.40 REF			.055 REF		
D	4.00 BSC			.157 BSC		
E	4.00 BSC			.157 BSC		
E4	1.40 REF			.055 REF		
E3	0.73 REF			.029 REF		
E2	1.78	1.88	1.98	.070	.074	.078
L	0.30	0.40	0.50	.012	.016	.020
e	0.50 PITCH			.020 PITCH		
N	16			16		
ND	4			4		
NE	4			4		
aaa	0.15			.0059		
bbb	0.10			.0039		
ccc	0.10			.0039		
ddd	0.05			.0019		

Tape and Reel Details: MLPQ 4x4 - 14L

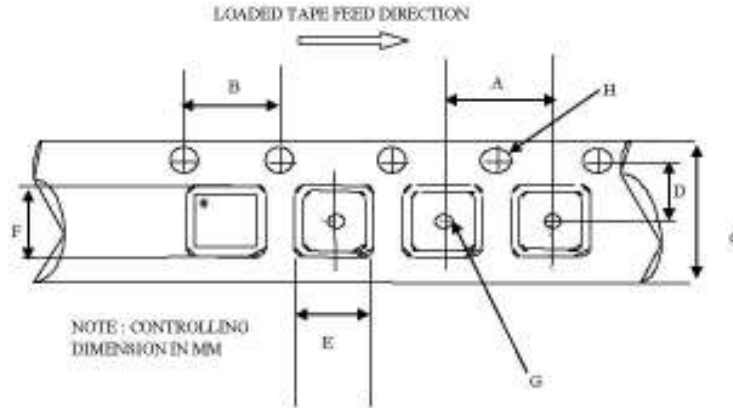

CARRIER TAPE DIMENSION FOR MLPQ4X4V

Code	Metric		Imperial	
	Min	Max	Min	Max
A	7.90	8.10	0.311	0.358
B	3.90	4.10	0.154	0.161
C	11.70	12.30	0.461	0.484
D	5.45	5.55	0.215	0.219
E	4.25	4.45	0.168	0.176
F	4.25	4.45	0.168	0.176
G	1.50	n/a	0.059	n/a
H	1.50	1.60	0.059	0.063

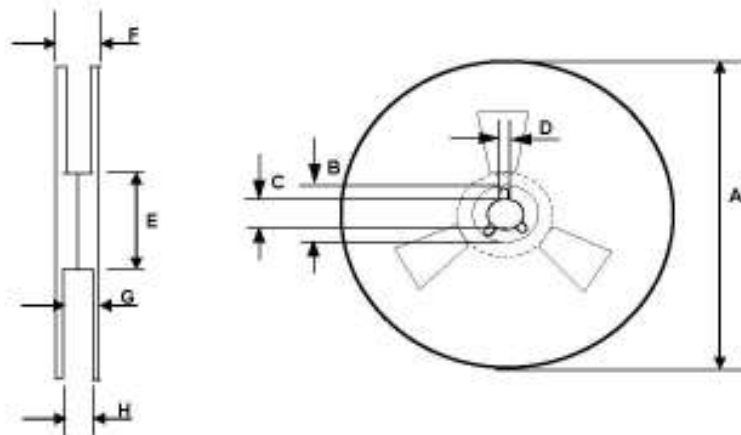

REEL DIMENSIONS FOR MLPQ4X4V

Code	Metric		Imperial	
	Min	Max	Min	Max
A	329.60	330.25	12.976	13.001
B	20.95	21.45	0.824	0.844
C	12.80	13.20	0.503	0.519
D	1.95	2.45	0.767	0.096
E	98.00	102.00	3.858	4.015
F	n/a	18.40	n/a	0.724
G	14.50	17.10	0.570	0.673
H	12.40	14.40	0.488	0.566

Part Marking Information

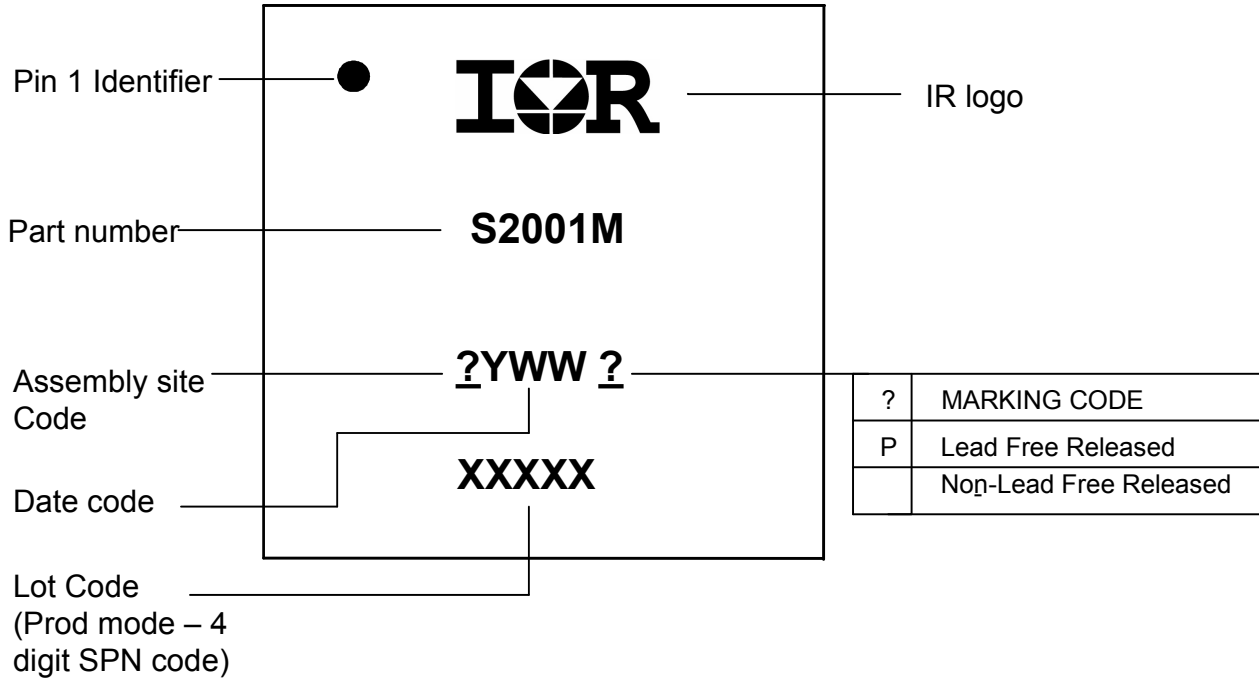

Ordering Information

Base Part Number	Package Type	Standard Pack		Complete Part Number
		Form	Quantity	
IRS2001	MLPQ 4x4-14L	Tube/Bulk	92	IRS2001MPBF
		Tape and Reel	3,000	IRS2001MTRPBF

The information provided in this document is believed to be accurate and reliable. However, International Rectifier assumes no responsibility for the consequences of the use of this information. International Rectifier assumes no responsibility for any infringement of patents or of other rights of third parties which may result from the use of this information. No license is granted by implication or otherwise under any patent or patent rights of International Rectifier. The specifications mentioned in this document are subject to change without notice. This document supersedes and replaces all information previously supplied.

For technical support, please contact IR's Technical Assistance Center
<http://www.irf.com/technical-info/>

WORLD HEADQUARTERS:
 233 Kansas St., El Segundo, California 90245
 Tel: (310) 252-7105

Revision History

Date	Comment
9/15/09	Initial draft converted from SO8 data sheet
06/18/2010	Included Qual Info Page